

# ACOUSTICAL CEILING CLOUD TRANSITION

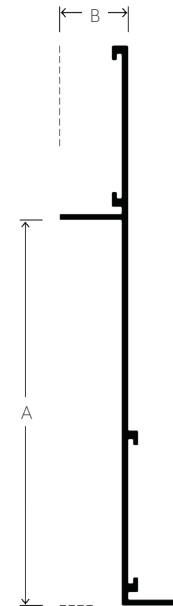
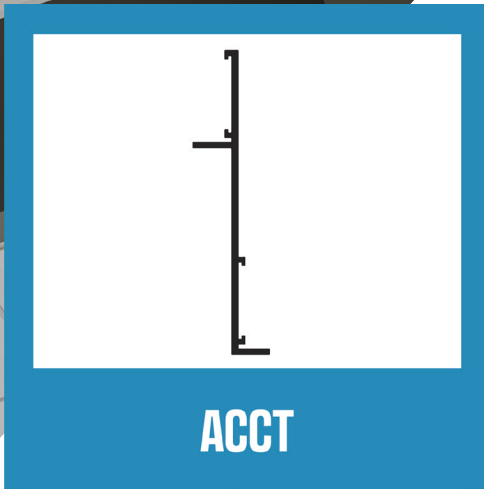

## APPLICATION

Flannery's Acoustical Ceiling Cloud Transition (ACCT) allows for the transition from one suspended acoustical ceiling plane to an upper or lower ceiling plane that also utilizes acoustical tiles. The Cloud Transition gives the designer the ability to transition their ceiling heights without the need for framing. Clips and Splices are included.

## SPECIFICATION

- Standard extruded aluminum alloy 6063 T5
- Typical .050" nominal wall thickness or greater
- Come in 10-foot lengths
- Stocked in Cloud White Kynar Paint and Mill Finish (for field painting and priming)
- Clear Anodized, other factory finishes and custom paint are available

PART NO.	"A" HEIGHT	"B" WIDTH
ACCT 200	2"	¾"
ACCT 400	4"	¾"
ACCT 600	6"	¾"
ACCT 800	8"	¾"
ACCT 1000	10"	¾"
ACCT 1200	12"	¾"

# ACOUSTICAL CEILING CLOUD TRANSITION

## INSTALLATION DETAIL

Connect Acoustical Ceiling Cloud Transition trims to the suspended ceiling grid using the Ceiling Grid Trim Clips included. Rotate the Ceiling Grid Trim Clip into the slots on the back of the ACCT and tighten the lock screw. Then attach the Ceiling Grid Trim Clip to the acoustical ceiling grid.

Repeat these steps again when attaching the lower half of the Acoustical Ceiling Cloud Transition trim to the other level of the acoustical ceiling grid. Use the included Ceiling Cloud Trim Splices to connect one piece of trim to the next for level and clean butt joints. All Strata Ceiling Trims must be cut accurately and installed with tight, neat joints.

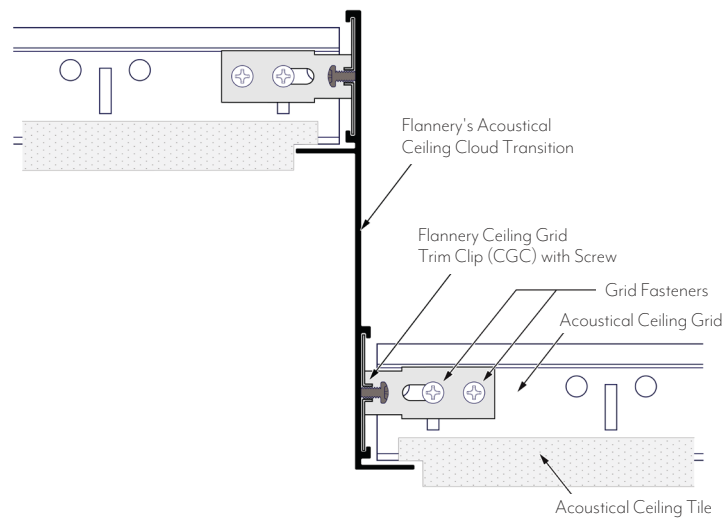

# ACCT CUSTOM FABRICATION

## CORNERS (WELDED & MITERED)

Flannery offers prefabricated Inside and Outside Corners for intricate ceiling designs that utilize any of the Strata Ceiling Trims we manufacture. Factory welded corners allow the installer to maintain a straight and true layout of any rectangle or square ceiling design. The corners are painted to match the straight pieces of your specified Strata Ceiling Trims for a perfect cloud aesthetic. Prefabricated corners are factory mitered and then welded together to prevent separation during the edge trim installation. Factory welded corners come with 8" legs in each direction, however, custom leg lengths can be ordered. Factory mitering for custom ceiling projects such as a square or rectangular ceiling are available. Flannery can even produce "Cloud Kits" where the ceiling is cut and mitered to size and comes with bent corner Splices to join the corners of the ceilings together without welding.

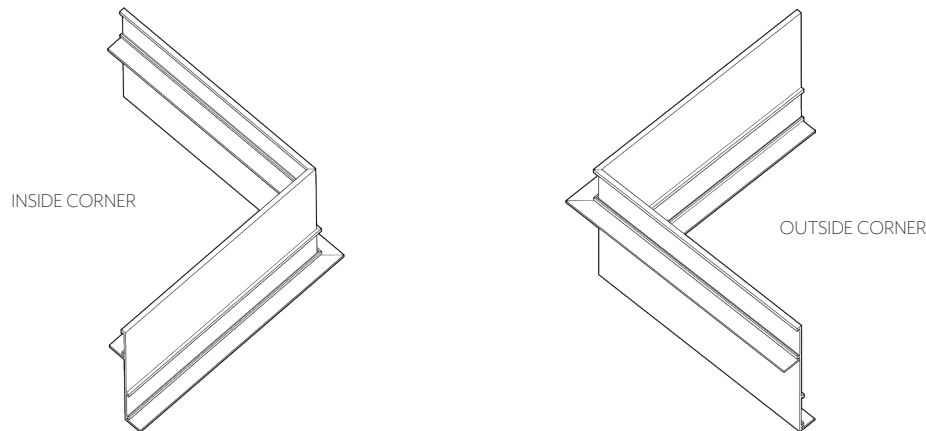

## RADIUS

We can't call our ceiling products "Strata Cloud" trims if we can't make them look like a real cloud. This type of ceiling art would not be possible if we were unable to bend our trims to a ceiling design's curves. Several of Flannery's Strata Ceiling trims can be bent and radiused to follow the contours and turns of a curved ceiling or cloud detail. This fabrication occurs in-house and allows for the designer to have the freedom to run our trim along the edge of a suspended ceiling and create diverse and unique cloud shapes. Since Flannery does all its own bending, we can ensure the proper radius dimension is maintained in order to reduce overall lead times for custom fabrication. When a full circle is specified, we can cut the required pieces to length to allow for quick installation and no field cutting. Every piece of radius is masked with vinyl tape to protect the factory paint finish. Please call or email Flannery ([info@flannerytrim.com](mailto:info@flannerytrim.com)) with your Acoustical Ceiling Cloud Transition trim radius inquiries.

# CLOUD KITS

If you're looking for an easy Cloud installation option, check out Flannery's Cloud Kits. These are pre-cut and ready to ship versions of standard sized squares, rectangles and round ceiling clouds. A variety of sizes are available, and each one comes cut to size so there is no field cutting or adjustment needed. The kits also come with all of the hardware (grid clips and trims splices) needed to assemble and hang them in the field.

While we do offer standard sizes, we can also mass produce custom sizes that are factory cut to size as well. Flannery's Cloud Kits will reduce both material and labor costs since they eliminate both field waste and time spent cutting product on-site. Call to learn more about Flannery's round and angular Cloud Kits.

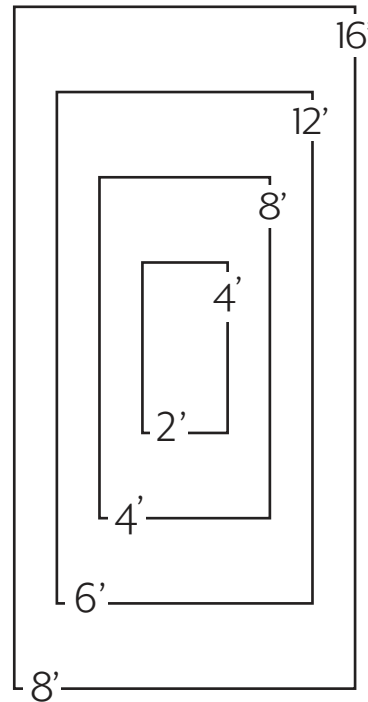
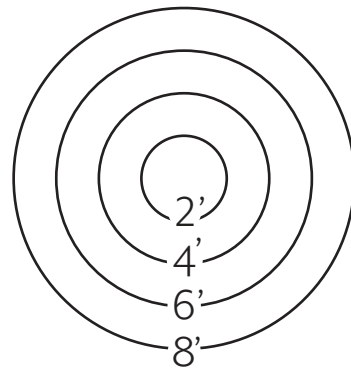
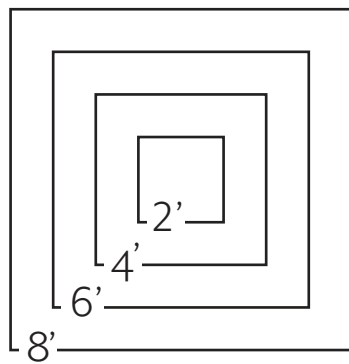

# SPECIFICATIONS FOR STRATA CEILING TRIM

## PRODUCT SPECIFICATIONS

Flannery recommends that any installer of Strata Ceiling Trims properly layout and coordinate the installation of trims along with the ceiling grid and hanger wires that will be utilized in the installation of the ceiling. The suspended ceiling grid and hanger manufacturer should be consulted prior to installation of grid, trim, ceiling tiles or gypsum board for load and seismic limitations or requirements.

## INSTALLATION INSTRUCTIONS FOR ATTACHING STRATA CEILING TRIMS TO ACOUSTICAL CEILING GRID

1. Installer must insert Flannery's Ceiling Grid Clip into the slots on the back of the Strata trim where the ceiling grid runs perpendicular to the trim. The Grid Clip must have its set screw tightened to hold the clip in place along the back of the trim. Flannery's 45-degree Ceiling Grid Clip is inserted the same way, but without a set screw.
2. Once the Ceiling Grid Clip is installed, the trim is then lifted into place along the perpendicular ceiling grid and a screw or pop-rievet is inserted through the holes on the Ceiling Grid Clip and into the ceiling grid.
3. Installer then inserts Flannery's Ceiling Trim Splices into the end of the newly installed piece of trim in order to connect it to the next piece of trim and secures them by tightening the splice's set screw.

## INSTALLATION INSTRUCTIONS FOR ATTACHING STRATA CEILING TRIMS TO DRYWALL CEILING GRID

1. Installer must insert Flannery's Ceiling Grid Clip into the slots on the back of the Strata trim where the ceiling grid runs perpendicular to the trim. The Grid Clip must have its set screw tightened to hold the clip in place along the back of the trim. Flannery's 45-degree Ceiling Grid Clip is inserted the same way, but without a set screw.
2. Once the Ceiling Grid Clip is installed, the trim is then lifted into place along the perpendicular ceiling grid and a screw or pop-rievet is inserted through the holes on the Ceiling Grid Clip and into the ceiling grid.

3. Installer then inserts Flannery's Ceiling Trim Splices into the end of the newly installed piece of trim in order to connect it to the next piece of trim and secures them by tightening the splice's set screw.
4. Drywall or gypsum board is then hung to the drywall ceiling grid with the tapeable (or mud) flange of the Drywall Ceiling trims laying flat over the drywall.
5. A drywall screw is then inserted through the Drywall Ceiling trim flange, through the drywall and into the ceiling grid to secure it in place.
6. Drywall compound joint and mesh tape is then applied over the trim's mud flange and the edge of the drywall, while being feathered with a mud knife.

## INSTALLATION INSTRUCTIONS FOR ATTACHING STRATA CEILING TRIMS DIRECTLY TO THE FRAMING

1. Trims that attach directly to framing should be attached with an approved fastener to the substrate at 16" or 24" on center.
2. When available, installer can use Flannery's Ceiling Trim Splice to connect one piece of trim to the next for tight and clean butt joints.

## STRATA TRIM ALUMINUM ALLOY & COMPOSITION

Flannery's Aluminum Strata Ceiling Trims are standard extruded aluminum alloy 6063 T5 and have a typical .050" or greater nominal wall thickness. Extruded Aluminum Ceiling Trims are aesthetic trims which are not intended to hold or support the full weight of any panel or gypsum board system. Strata Ceiling Trims meet or exceed ASTM B221 for extruded aluminum products. Aluminum Strata Ceiling Trims come in 10' lengths typically and shall have a standard stock finish of Mill Finish (for field priming & painting) or a "Cloud White" factory applied Kynar® paint finish. Other factory finishes including liquid or powder coated paint, Chem-Film, Primer and special Anodizing finishes are available. Other finishing options are available including polished and "wood grain" style finishes.

# GENERAL SPECIFICATIONS FOR FLANNERY TRIM

## PRODUCT SPECIFICATIONS

Flannery recommends that any installer of our Aluminum Trims properly layout and coordinate the installation of trims along with materials that will be utilized in the installation of the exterior wall system.

## FLANNERY ALUMINUM TRIM ALLOY & COMPOSITION

Flannery's Aluminum Trims are standard extruded aluminum alloy 6063 T5 and have a typical .050" or greater nominal wall thickness. Extruded Aluminum Trims are aesthetic trims which are not intended to hold or support the full weight of any Panel, Stucco, or Plaster system. Flannery's Trims meet or exceed ASTM B221 for extruded aluminum products.

Flannery's Aluminum Trims come in 10' lengths typically and shall have a standard stock finish of Mill Finish (for field priming & painting) or Clear Anodized (some may be stocked in Black Anodized). Other factory finishes including liquid or powder coated paint, Chem-Film, Primer and special Anodizing finishes are available. All of our other finishing options can be viewed on the next page.

## HANDLING ALUMINUM TRIMS

Personal protection equipment should be utilized when handling and installing aluminum trims. Gloves and eye protection must be worn when handling aluminum trims as well as ear protection when cutting.

## CUTTING ALUMINUM MOLDINGS

Flannery recommends that ten-foot lengths be used wherever possible. Aluminum Moldings can be cut with a chop saw, using a 125-150-tooth carbide-tip blade for non-ferrous metal. An abrasive cut-off wheel should not be used to cut aluminum trims. Blade lubricant (WD-40 or grease stick) must be applied to the blade before each cut. Lubricant should be cleaned from the trim prior to installation.

## STEPS FOR FIELD PAINTING MILL FINISH (RAW) ALUMINUM MOLDINGS

1. Clean and treat moldings in accordance with the paint manufacturer's specifications.
2. Use a primer recommended by the paint manufacturer's specifications.
3. Apply the paint coat according to the paint manufacturer's specifications.
4. Flannery makes no guarantees, nor accepts any responsibility, for the performance of field-applied coatings over anodized finishes.
5. If aluminum trim has an alternate finish, contact Flannery for field painting instructions.

## PLEASE NOTE

*This product sheet presents general guidelines and suggestions for the installation of Flannery trims and products. The purpose of these general guidelines and suggestions is to aid in a successful interior or exterior finish based on the Uniform Building Code and industry standards. No one catalog or product guide can address all of the unique specifics or installation details that occur from one project to another. Flannery recommends that every installer be familiar, or become acquainted with, common interior or exterior trim installation practices before installing any of Flannery's many trims and products. Flannery also recommends that the specifying architect, engineer, and general contractor be consulted with as well.*